



Cover 2:
Penthouse Gold

Cover 1:
Jive Silver

Cover 1:
Jive Silver

Gold Piping

Blaise Collection

foamflex™
Award Winning Seating Technology

Colours represented are to be used as a guide only.
Please refer to manufacturers swatch for a more accurate colour match.

Please note that colour shadings can vary slightly from each roll of fabric.
We cannot guarantee a precise match to these samples or between cut lengths and upholstered goods.

20/07/2020

BLAISE COVER GUIDE: STANDARD BACK ONLY

Please use this guide when ordering the following pieces to clarify cover options.

Corner Group: LH2, COR, RH2 (L2, CO, R2)

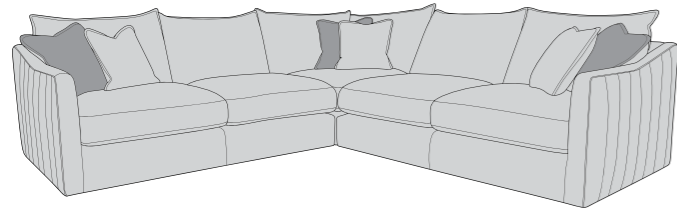

Corner Group: LH2, COR, RH1 (L2, CO, R1)

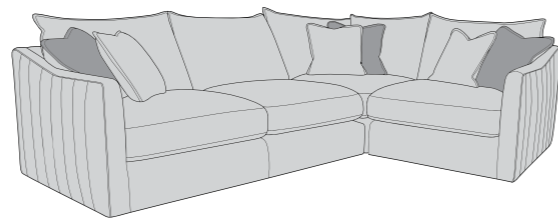

Corner Group: LH1, COR, RH2 (L1, CO, R2)

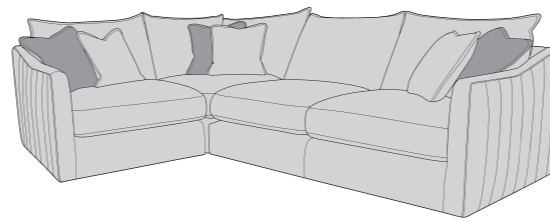

Corner Group: LH1, COR, RH1 (L1, CO, R1)

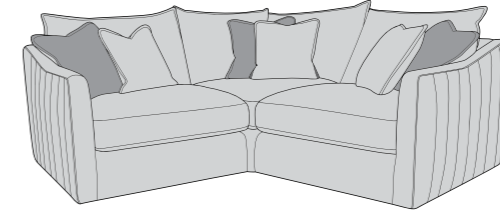

3 Seater Sofa (3ST)

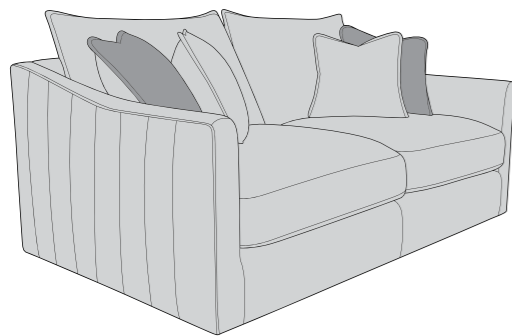

2 Seater Sofa (2ST)

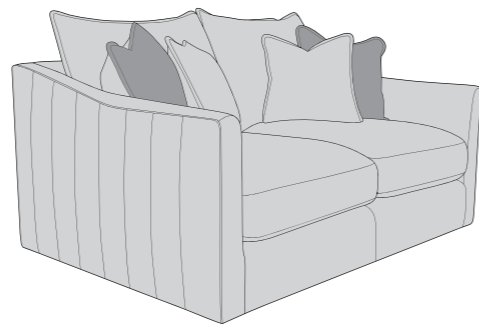

Arm Chair (1ST)

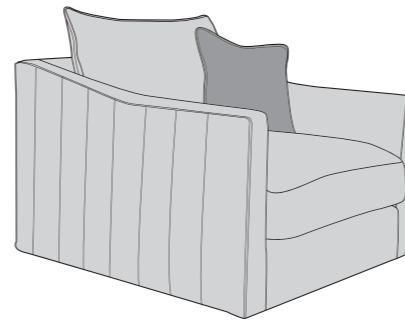

Armless Unit (ALU)

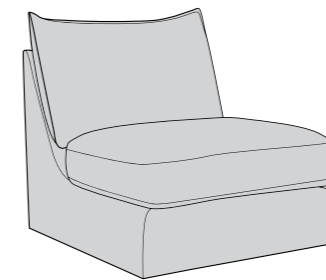

COVER 1
(BODY & SMALL SCATTERS)

COVER 2
(MEDIUM SCATTERS, SMALL ON CHAIR)

Scatter Cushions

Medium Scatters
(small on chair)

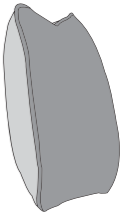

Flanged Edge
Front = Cover 2
Back = Cover 1

Small Scatters

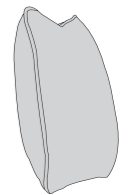

Flanged Edge
Front = Cover 1
Back = Cover 1

ACCENT PIECES

Bond Swivel Chair (SWC)

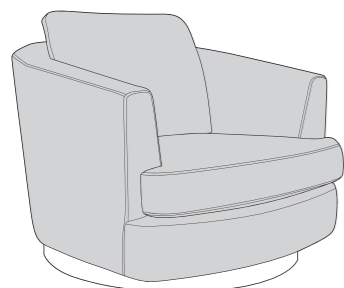

Bond Footstool (FST)

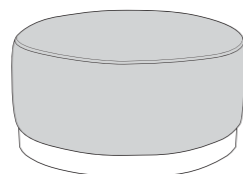

Blaise Large Footstool (FST)

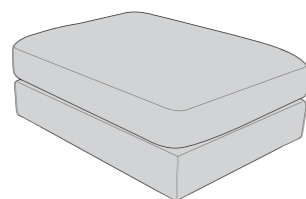

BLAISE DIMENSIONS (CM)

AVAILABLE PIECES	HEIGHT 1	OUTBACK HEIGHT	WIDTH 2	DEPTH 3	ARM HEIGHT	SEAT HEIGHT 4	SEAT DEPTH 5	SEAT WIDTH 6	ACCESS DIAGONAL 7	WEIGHT (KG)	SCATTER CUSHION NO.
LH2, COR, RH2 GROUP	88	70	272	272	60	47	N/A	N/A	N/A	140	6 (3 Medium, 3 Small)
LH2, COR, RH1 GROUP or LH1, COR, RH2 GROUP	88	70	272	183	60	47	N/A	N/A	N/A	124	6 (3 Medium, 3 Small)
LH1, COR, RH1 GROUP	88	70	183	183	60	47	N/A	N/A	N/A	108	6 (3 Medium, 3 Small)
LH2/RH2 UNIT	88	70	167	105	60	47	66	155	194	52	2 (1 Medium, 1 Small)
LH1/RH1 UNIT	88	70	78	105	60	47	66	N/A	N/A	36	2 (1 Medium, 1 Small)
COR - CORNER UNIT	88	70	105	105	N/A	47	66	N/A	145	36	2 (1 Medium, 1 Small)
ALU - ARMLESS UNIT	88	70	75	105	N/A	47	66	N/A	129	25	N/A
3 SEATER SOFA (3ST)											
88 70 176 105 60 47 66 151 200 63 4 (2 Medium, 2 Small)											
2 SEATER SOFA (2ST)											
88 70 155 105 60 47 66 130 183 56.5 4 (2 Medium, 2 Small)											
ARM CHAIR (1ST)											
88 70 100 105 60 47 66 75 140 44 1 Small											
ACCENT PIECES											
BOND SWIVEL CHAIR (SWC)											
74 84 100 107 64 43 57 96 117 40.5 N/A											
BOND FOOTSTOOL (FST)											
34 N/A 65 65 N/A N/A N/A N/A 65 12.5 N/A											
LARGE FOOTSTOOL P (FST)											
47 N/A 105 78 N/A N/A N/A N/A 128 18 N/A											



* Hardwood & composite board frame.

* Dowelled, screwed, glued & stapled joinery.

* Gold, Chrome and Black piping available.

* Fibre filled reversible backs for added comfort.

* Feather filled scatters included.



* Award winning foamflex seat interior with 5 year guarantee.

* Serpentine seat springs & silent wire.

* Elasticated back webbing.

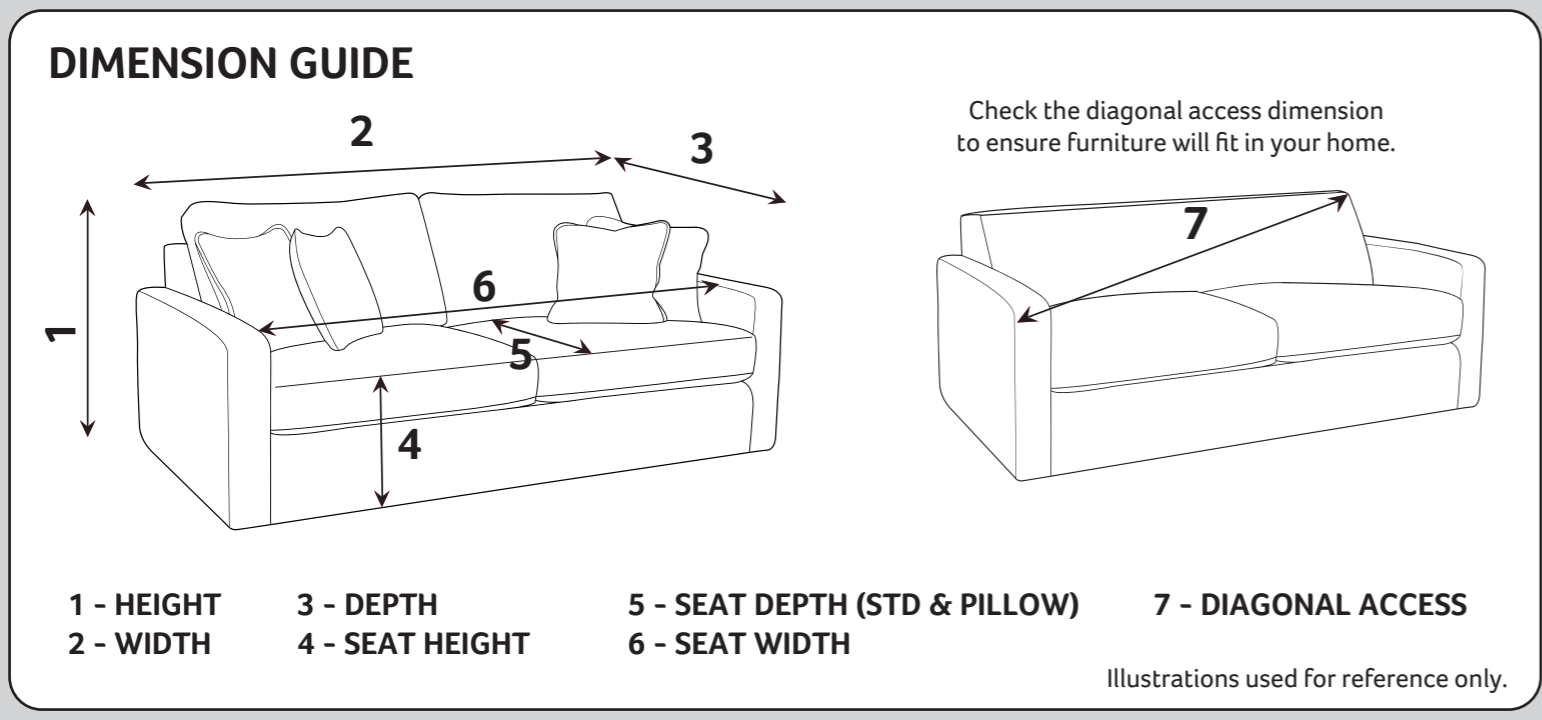

foamflex™

Our new expertly engineered foam seat interior gives you the comfort of fibre with the retention of foam.

CARE GUIDE

To improve the longevity of your hand-made furniture, we recommend rotating cushions (where applicable).

For further information on maintaining your furniture, please refer to the Care Guide located under the seat platform.



Our foamflex seat interiors have been granted the FIRA GOLD Award, a mark of quality under-pinning all necessary testing of the product materials, design and production techniques.

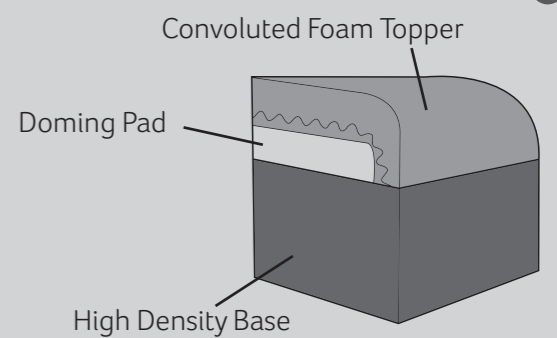

BOND ACCENT BASE OPTIONS:

Brushed Chrome



Brushed Gold



Please note : All dimension are approximate. Allow tolerance of +/- 2.5cm.

A choice of Gold, Chrome or Black piping is available except on accent pieces and armless unit.



20/07/2020