



Cover 1:
Rich Stone

Cover 2:
Sweetie Plum

Dark Wood Feet

Dexter Collection

Colours represented are to be used as a guide only.
Please refer to manufacturers swatch for a more accurate colour match.

Please note that colour shadings can vary slightly from each roll of fabric.
We cannot guarantee a precise match to these samples or between cut lengths and upholstered goods.

Extra Flex[®]
Soft, Supportive Seating

29/07/2019

DEXTER COVER GUIDE - STANDARD BACK

Please use this guide when ordering the following pieces to clarify cover options.

STANDARD BACK

L2, CO, R1 (LH2, COR, RH1) Group

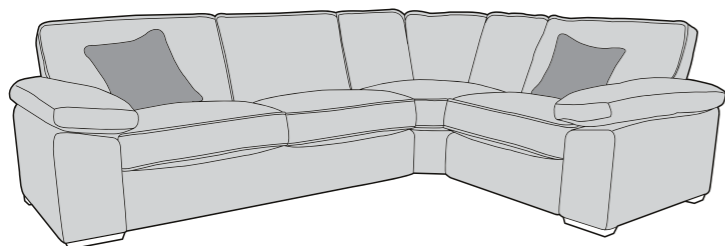

L1, CO, R2 (LH1, COR, RH2) Group

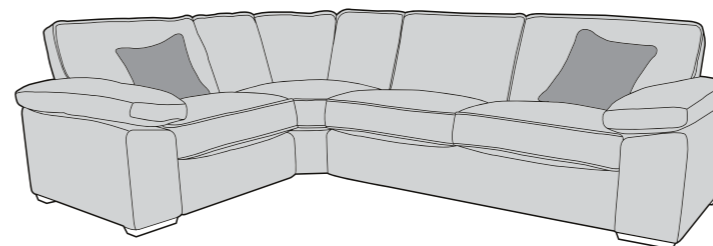

L2, CO, R2 (LH2, COR, RH2) Group

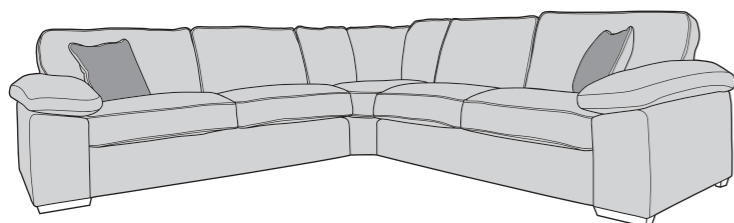

L1, CO, R1 (LH1, COR, RH1) Group

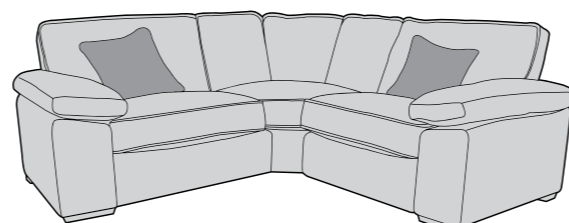

AU (ALU)

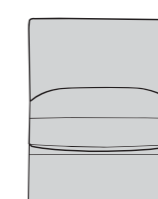

3 Seater Sofa (3ST)

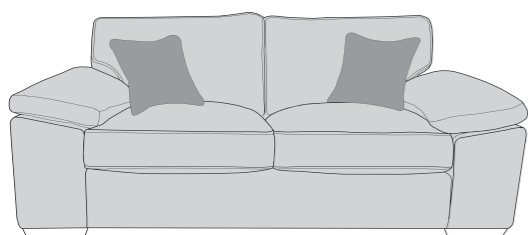

2 Seater Sofa (2ST)

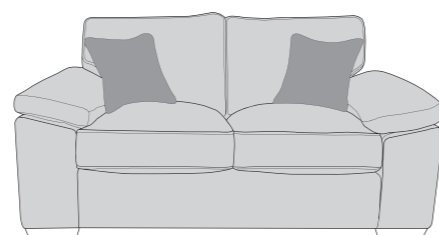

Love Chair (LOV)

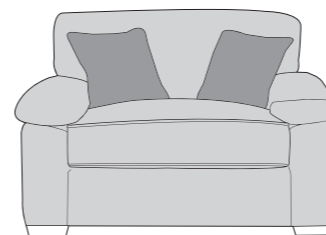

Arm Chair (1ST)

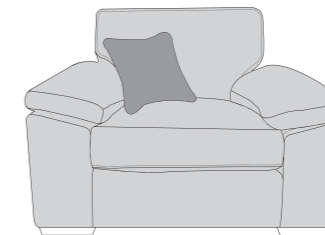

3 Seater Sofa Bed (3SB, 3DB)
(Available in Standard or Deluxe)

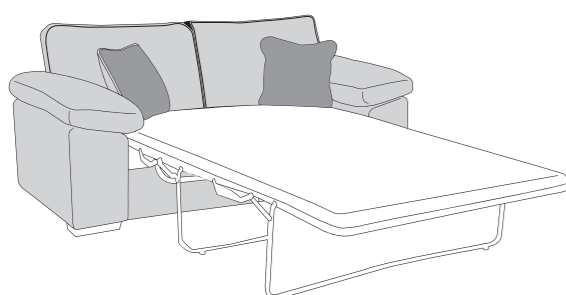

2 Seater Sofa Bed (2SB, 2DB)
(Available in Standard or Deluxe)

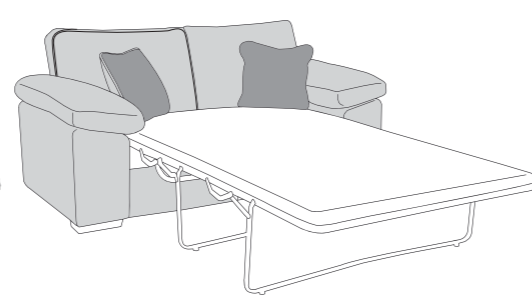

Chair Sofa Bed (1SB, 1DB)
(Available in Standard or Deluxe)

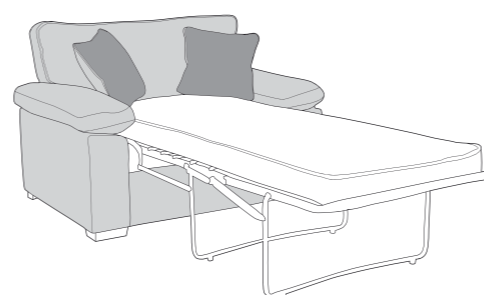

Dexter (Luman) Swivel Chair (SWC)

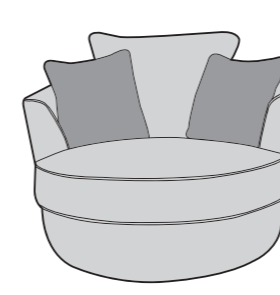

Dexter (Cuddler) Footstool (FST)

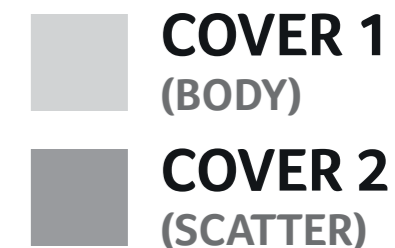
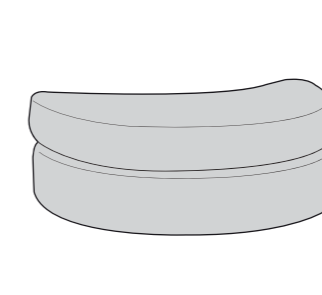

Scatter Cushions

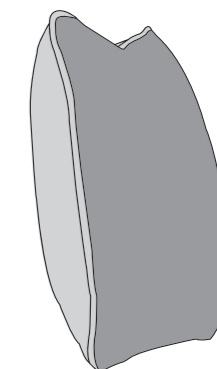

Front = Cover 2
Piping = Cover 1
Back = Cover 1

ACCENT PIECES

Storage Footstool F (FSS)

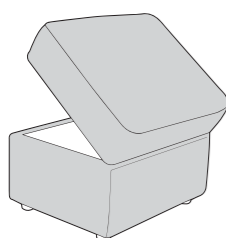

DEXTER DIMENSIONS (CM)

AVAILABLE PIECES	HEIGHT 1	WIDTH 2	DEPTH 3	SEAT HEIGHT 4	SEAT DEPTH 5	SEAT WIDTH 6	ACCESS DIAGONAL 7	WEIGHT (KG)	SCATTER CUSHIONS
L2, CO, R1 GROUP or L1, CO, R2 GROUP	96	298	212	55	58	N/A	N/A	124.5	2
L2, CO, R2 GROUP	96	298	298	55	58	N/A	N/A	140.5	2
L1, CO, R1 GROUP	96	212	212	55	58	N/A	N/A	108.5	2
L2/R2 UNIT	96	192	97	55	58	144	208	53.5	1
L1/R1 UNIT	96	106	97	55	58	69	139	37.5	1
CO - CORNER UNIT	96	106	97	55	58	65	149	33.5	N/A
AU - ARMLESS UNIT	96	80	97	55	58	80	122	23	N/A
SOFA BEDS - STD BACK ONLY									
3S (140CM SOFA BED) STANDARD	96	206	97	64	58	139	226	87	2
2S (120CM SOFA BED) STANDARD	96	185	97	64	58	115	206	76	2
1S (80CM SOFA BED) STANDARD	96	135	97	64	58	78	159	63	2
3D (140CM SOFA BED) DELUXE	96	206	97	64	58	139	226	100	2
2D (120CM SOFA BED) DELUXE	96	185	97	64	58	115	206	95.5	2
1D (80CM SOFA BED) DELUXE	96	135	97	64	58	78	159	82.5	2
OPEN DEPTH OF SOFA BEDS 226CM									
ACCENT PIECES									
STORAGE FOOTSTOOL (F)	45	63	50	N/A	N/A	N/A	75	12.5	N/A

- * Hardwood & composite board frame.
- * Dowelled, screwed, glued & stapled joinery.
- * Light & Dark Wood foot options.

- * Available with standard back option.
- * ExtraFlex high comfort seat cushions.
- * Fibre filled backs for added comfort.

- * Serpentine seat & silent wire.
- * Superloop back springs.

SOFABEDS: 2 SLEEP OPTIONS

STANDARD ACTION & FOAM MATTRESS

A three fold metal action with a sprung 'polyprop' base. Complemented by a high performance foam mattress. For occasional use only.



Mattress Thickness: 6cm

Mattress Length: 185cm

3 fold action is 140Kg total max occupancy weight

140cm sofa bed:

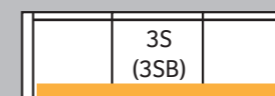

Mattress Width: 133cm

120cm sofa bed:

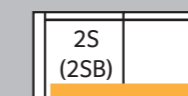

Mattress Width: 113cm

80cm chair bed:



Mattress Width: 73cm

DELUXE ACTION & SPRUNG MATTRESS

A two fold metal action with beech slats. Complemented by a deluxe sprung mattress. For everyday use.



Mattress thickness: 11.5cm

Mattress Length: 183cm

2 fold action is 160Kg total max occupancy weight

140cm sofa bed:

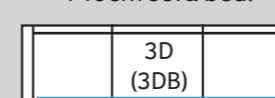

Mattress Width: 132cm

120cm sofa bed:

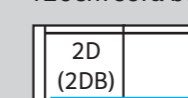

Mattress Width: 114cm

80cm chair bed:

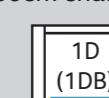

Mattress Width: 76cm

Sofa beds available as standard back only

DIMENSION GUIDE

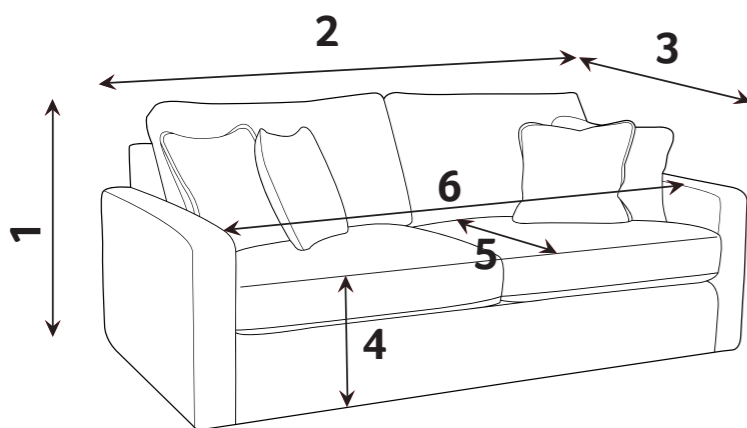

Check the diagonal access dimension to ensure furniture will fit in your home.

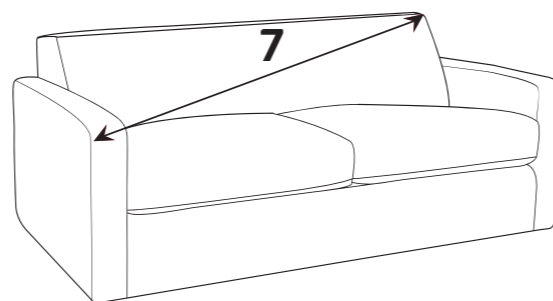

1 - HEIGHT
2 - WIDTH

3 - DEPTH
4 - SEAT HEIGHT

5 - SEAT DEPTH (STD & PILLOW)
6 - SEAT WIDTH

7 - DIAGONAL ACCESS

Illustrations used for reference only.

Please note : All dimensions are approximate. Allow tolerance of +/- 2.5cm.

Extra Flex®

A high density foam base seat interior with a hand-rolled carded fibre, channelled topper which provides both softness and support.

CARE GUIDE

Extraflex seat cushions should be **plumped up on a regular basis** to help maintain the aesthetical appeal of your upholstery, the plumping of cushions is essential to help retain the comfort and softness of any piece of upholstered furniture.

To improve the longevity of your hand-made furniture, we recommend rotating cushions (where applicable).

For further information on maintaining your furniture please refer to the care guide located under the seat platform.

Beech (Light)

Mid Oak

Brown (dark)

FOOT OPTIONS:



Wood is a natural product and will vary in shade/colour from item to item. Feet may require fitting.

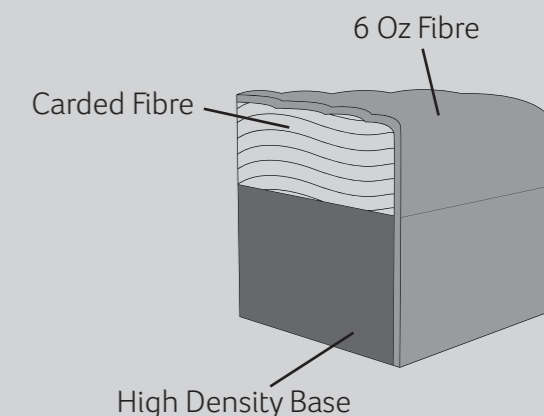

FSC® C116126
The mark of responsible forestry