



Cover 1:  
Grace Platinum

Cover 2:  
Festival Seafoam

Dark Ash Feet

# Fairfield Collection

Colours represented are to be used as a guide only.  
Please refer to manufacturers swatch for a more accurate colour match.

Please note that colour shadings can vary slightly from each roll of fabric.  
We cannot guarantee a precise match to these samples or between cut lengths and upholstered goods.

**COMFI-FLEX**

06/07/2020

# FAIRFIELD COVER GUIDE - STANDARD BACK

Please use this guide when ordering the following pieces to clarify cover options.

## STANDARD BACK

LH2, RFC, FST (L2, RFC, P) Group

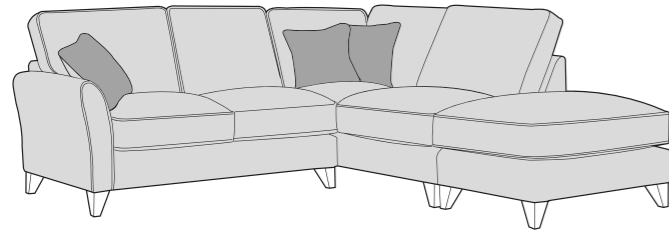

FST, LFC, RH2 (P, LFC, R2) Group

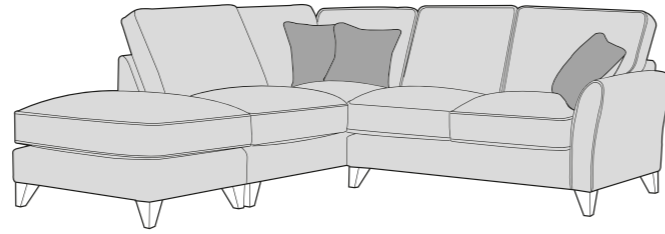

LH2, R2C (L2, R2C) Group

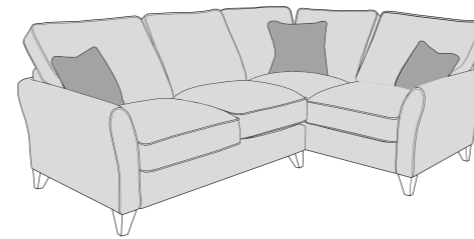

L2C, RH2 (L2C, R2) Group

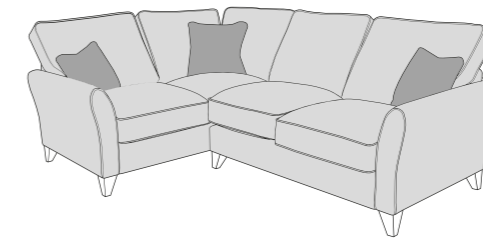

4 Seater Sofa (4ST)

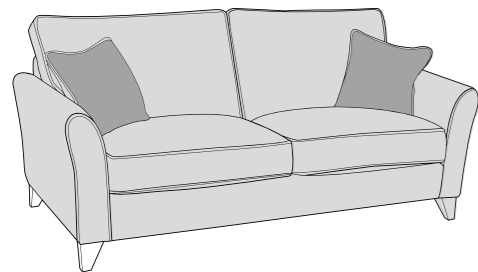

3 Seater sofa (3ST)

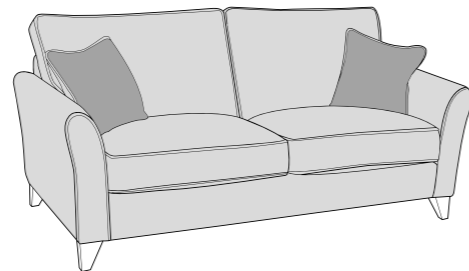

2 Seater sofa (2ST)

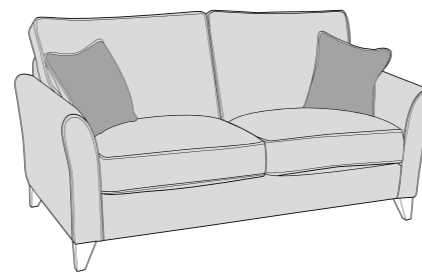

Love chair (LOV)

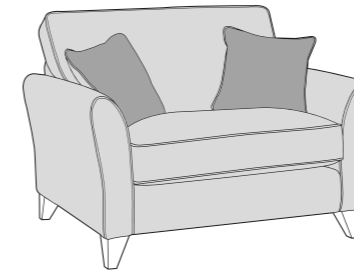

Arm chair (1ST)

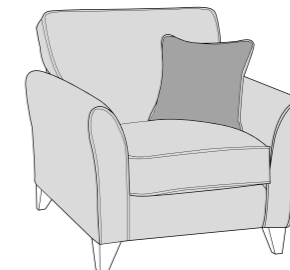

3 Seater Sofa Bed (3SB, 3DB)  
(Available in Standard or Deluxe)

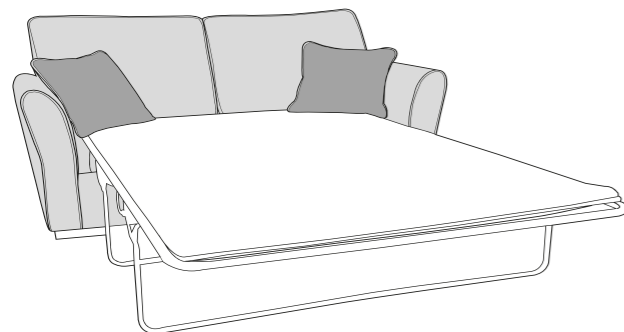

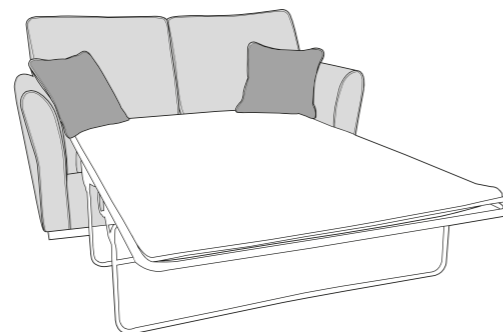

2 Seater Sofa Bed (2SB, 2DB)  
(Available in Standard or Deluxe)

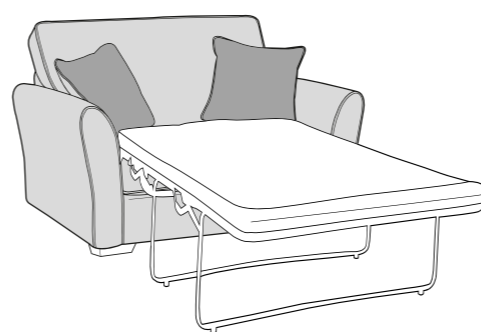

Chair Sofa Bed (1SB, 1DB)  
(Available in Standard or Deluxe)



-  **COVER 1**  
(BODY)
-  **COVER 2**  
(SCATTER)

Standard Back  
Scatter Cushions

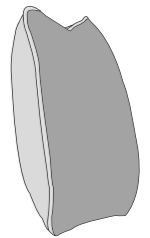

Front = Cover 2  
Piping = Cover 1  
Back = Cover 1



**APPROVED MEMBER**



# FAIRFIELD COVER GUIDE - PILLOW BACK

Please use this guide when ordering the following pieces to clarify cover options.

## PILLOW BACK

LH2, RFC, FST (L2, RFC, P) Group

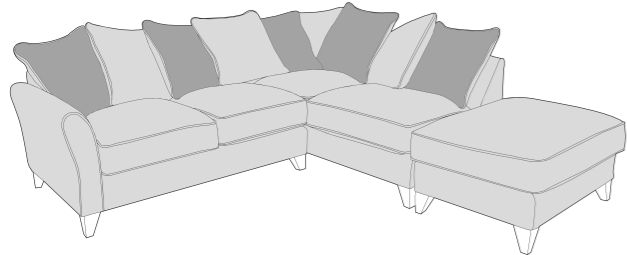

FST, LFC, RH2 (P, LFC, R2) Group

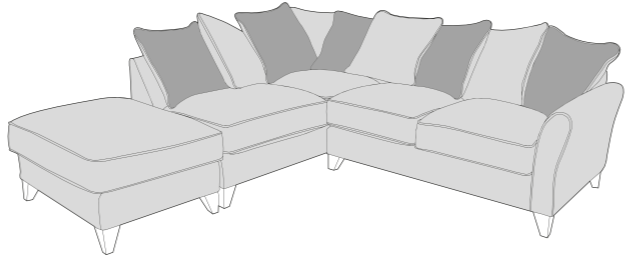

LH2, R2C (L2, R2C) Group

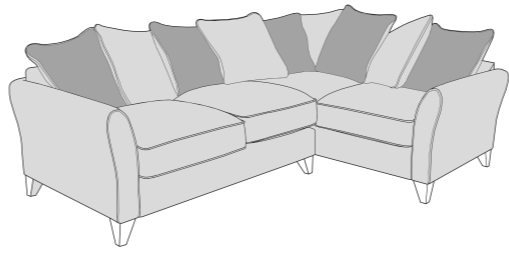

L2C, RH2 (L2C, R2) Group

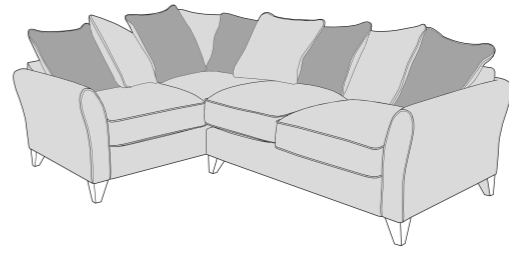

4 Seater Sofa (4ST)

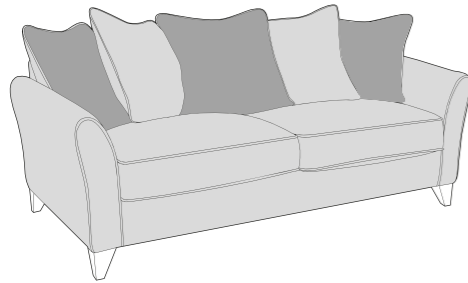

3 Seater sofa (3ST)

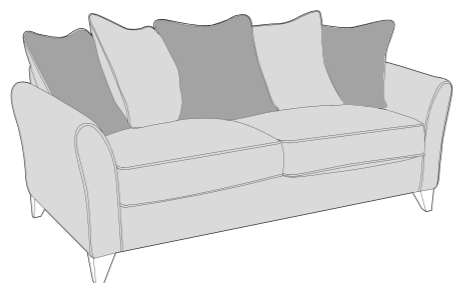

2 Seater sofa (2ST)

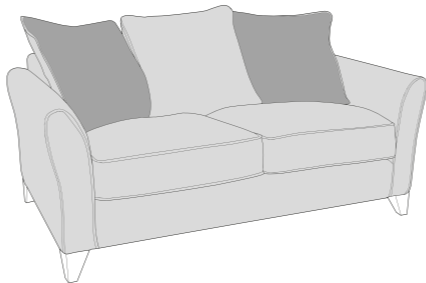

**COVER 1**  
(BODY)

**COVER 2**  
(PILLOW)

**Pillow Back Cushions**

Front = Cover 2  
Piping = Cover 1  
Back = Cover 1

## ACCENT PIECES

Large Footstool (FST)

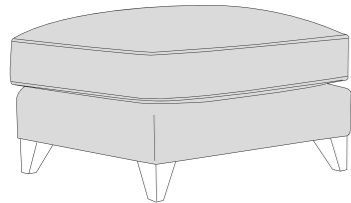

Storage Footstool (FSS)

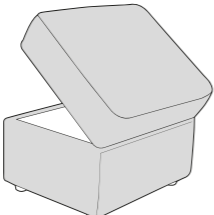

**APPROVED MEMBER**



# FAIRFIELD DIMENSIONS (CM)

AVAILABLE PIECES	HEIGHT 1	OUTBACK HEIGHT	WIDTH 2	DEPTH 3	ARM HEIGHT	SEAT HEIGHT 4	SEAT DEPTH (STD) 5	SEAT DEPTH (PILLOW) 5	SEAT WIDTH 6	ACCESS DIAGONAL 7	WEIGHT (KG)	PILLOW BACK NUMBER	SCATTER CUSHIONS (STD)
LH2/RFC/FST GROUP FST/LFC/RH2 GROUP	98	72.5	248	249	66	55	55	58	189+147+72	N/A	101.5	9 (x5 cover 2/x4 cover 1)	3
LH2/R2C GROUP L2C/RH2 GROUP	98	72.5	248	178	66	55	55	58	189+130	N/A	89.5	9 (x5 cover 2/x4 cover 1)	3
LH2/RH2 UNIT	98	72.5	154	94	66	55	55	58	134	178	39.5	4 (x2 cover 2/x2 cover 1)	1
L2C/R2C UNIT	98	72.5	178	94	66	55	55	58	130	197	50	5 (x3 cover 2/x2 cover 1)	2
LFC/RFC UNIT	98	72.5	177	94	N/A	55	55	58	147	195	47	5 (x3 cover 2/x2 cover 1)	2
4 SEATER SOFA (4ST)	98	72.5	222	94	66	55	55	58	186	239	58.5	5 (x3 cover 2/x2 cover 1)	2
3 SEATER SOFA (3ST)	98	72.5	197	94	66	55	55	58	160	215	55	5 (x3 cover 2/x2 cover 1)	2
2 SEATER SOFA (2ST)	98	72.5	171	94	66	55	55	58	132	188	46.5	3 (x2 cover 2/x2 cover 1)	2
LOVE CHAIR (LOV)	98	72.5	127	94	66	55	55	58	93	153	39	N/A	2
ARM CHAIR (1ST)	98	72.5	95	94	66	55	55	58	62	131	37	N/A	1
<b>SOFA BEDS - STD BACK ONLY</b>													
1SB (80CM SOFA BED) STANDARD	98	72.5	127	94	66	55	55	N/A	93	153	54.5	N/A	2
1DB (80CM SOFA BED) DELUXE	98	72.5	127	94	66	55	55	N/A	93	153	65.5	N/A	2
2SB (120CM SOFA BED) STANDARD	98	72.5	166	94	66	55	55	N/A	132	188	64	N/A	2
2DB (120CM SOFA BED) DELUXE	98	72.5	166	94	66	55	55	N/A	132	188	83	N/A	2
3SB (140CM SOFA BED) STANDARD	98	72.5	186	94	66	55	55	N/A	152	209	70	N/A	2
3DB (140CM SOFA BED) DELUXE	98	72.5	186	94	66	55	55	N/A	152	209	91.5	N/A	2
<b>OPEN DEPTH OF SOFA BEDS 226CM</b>													
<b>ACCENT PIECES</b>													
LARGE FOOTSTOOL	55	N/A	72	94	N/A	55	N/A	N/A	N/A	118	15	N/A	N/A
STORAGE FOOTSTOOL	45	N/A	63	50	N/A	N/A	N/A	N/A	N/A	75	12.5	N/A	N/A

## SOFABEDS: 2 SLEEP OPTIONS

### STANDARD ACTION & FOAM MATTRESS

A three fold metal action with a sprung 'polyprop' base. Complemented by a high performance foam mattress. For occasional use only.

**Mattress Thickness: 6cm**

**Mattress Length: 185cm**

**3 fold action is 140Kg total max occupancy weight**

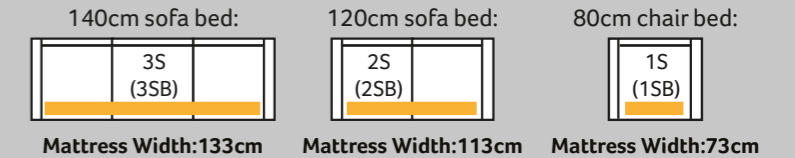

### DELUXE ACTION & SPRUNG MATTRESS

A two fold metal action with beech slats. Complemented by a deluxe sprung mattress. For everyday use.

**Mattress Thickness: 11.5cm**

**Mattress Length: 183cm**

**2 fold action is 160Kg total max occupancy weight**

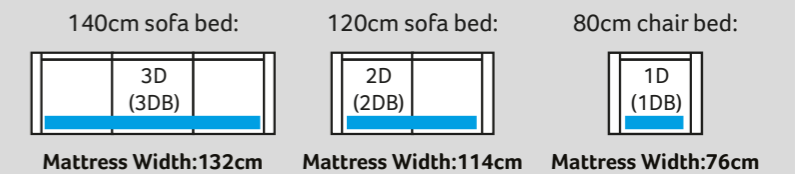

Sofa beds available as standard back only

\* Available with Pillow or Standard back cushions.

\* Reversible pillow back cushions for durability and comfort.

\* Fibre filled backs for added comfort.

\* Hardwood & composite board frame.

\* Dowelled, screwed, glued & stapled joinery.

\* Comfi-flex patented high resilient foam cushions.

## DIMENSION GUIDE

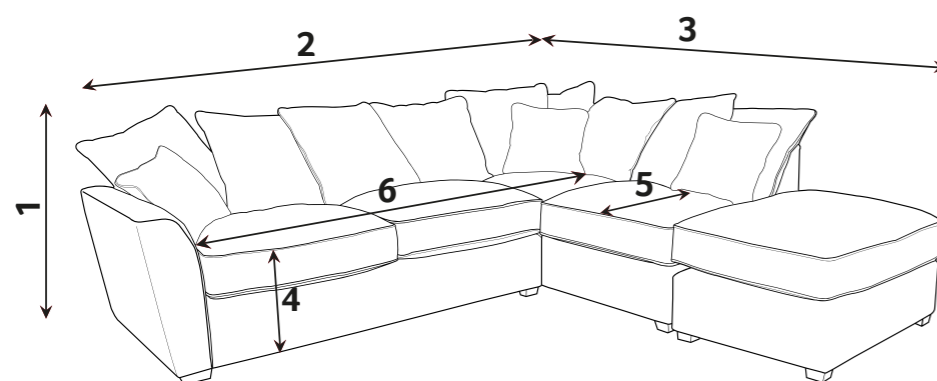

1 - HEIGHT  
2 - WIDTH

3 - DEPTH  
4 - SEAT HEIGHT

5 - SEAT DEPTH (STD & PILLOW)  
6 - SEAT WIDTH

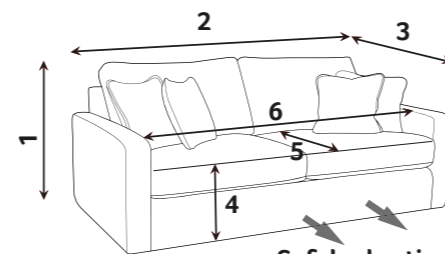

Sofabed action

Check the diagonal access dimension to ensure furniture will fit in your home.

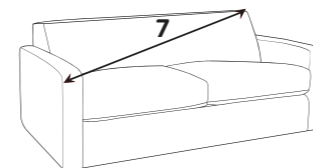

7 - DIAGONAL ACCESS

Illustrations used for reference only.

## COMFI-FLEX CARE GUIDE

100% high-density layered foam, domed for increased shape retention and topped with a soft layer for extra comfort. Comfi-flex is a high-performance luxury seat.

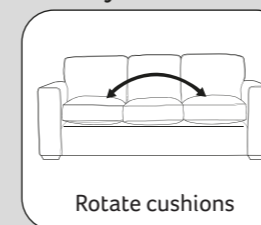

Rotate cushions

Comfi-flex Seat Cushions don't need to be plumped, but seat covers should be rotated and redressed regularly to realign the seat edges. Rotating seat cushions occasionally will also help to maintain your upholstery. For further information on maintaining your furniture please refer to the care guide located under the seat platform.

FOOT OPTIONS:

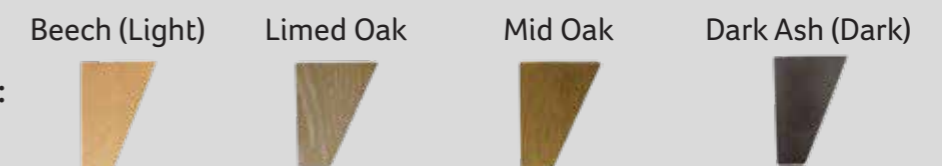

SOFA BED FEET:



Please note : All dimensions are approximate. Allow tolerance of +/- 2.5cm. Weight limits per seat: tested according with BS EN 12520:2010 & BS EN 1022:2005 for general domestic use which are based on persons weighing up to a maximum of 110kg.

Wood is a natural product and will vary in shade/colour from item to item. Feet may require fitting.

06/07/2020

